

MOBILE BATTERY BREAKER COMPACT

PATENT PENDING PCT/IB2006/053028



ENGINEERED AND PATENTED BY:

NEW ENERGY POWER s.r.l. - TURIN - ITALY

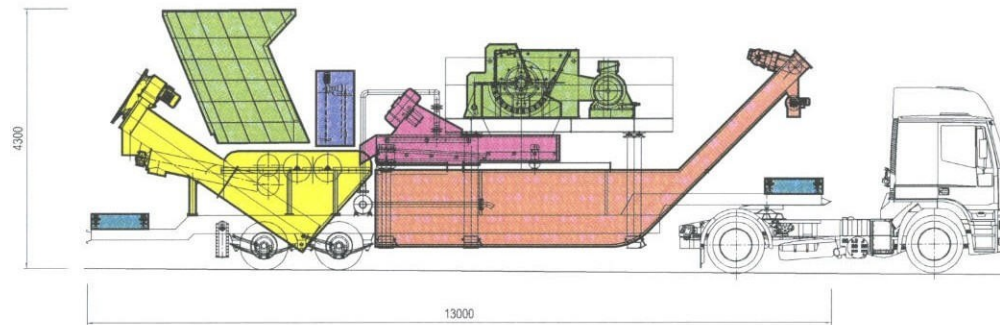

BREAKER ON TRAVEL - TRAILER 1



BREAKER ON TRAVEL - TRAILER 2

MOBILE BATTERY BREAKER COMPACT

PATENT PENDING PCT/IB2006/053028

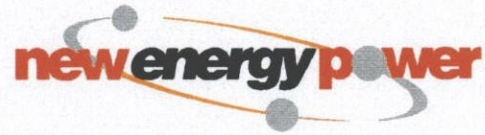

ENGINEERED AND PATENTED BY:
NEW ENERGY POWER s.r.l. - TURIN - ITALY

5 TO 7 t/h PRODUCTION CAPACITY
500 mq MINIMUM WORKING AREA NEEDED
N°2 OPERATOR NEEDED
DIESEL ELECTRIC GENERATOR
FILTER SCRUBBER SYSTEM
CONTROL ROOM

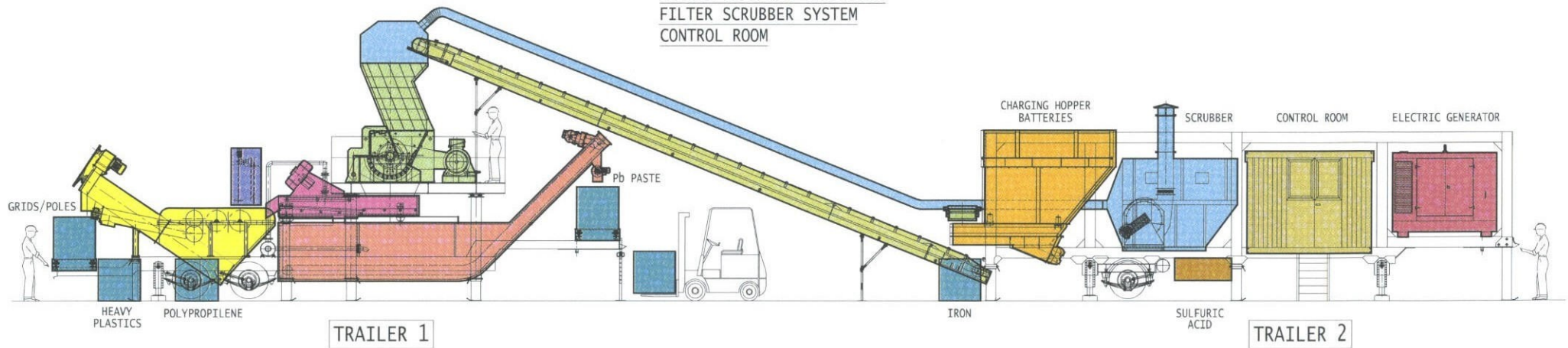

BREAKER WORKING ASSEMBLY

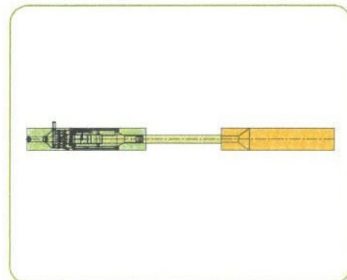

LAY-OUT ON LINEAR POSITION

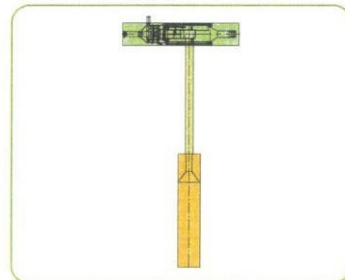

LAY-OUT ON PERPENDICULAR POSITION

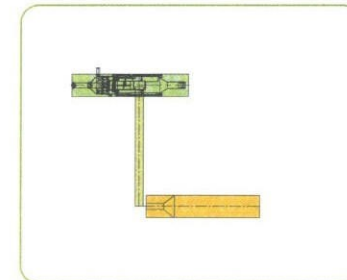

LAY-OUT ON PARALLEL POSITION

MOBILE BATTERY BREAKER COMPACT

PATENT PENDING PCT/162006/053028

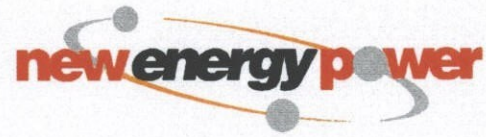

ENGINEERED AND PATENTED BY:
NEW ENERGY POWER s.r.l. - TURIN - ITALY

BATTERIES FEEDING

